

P.01

P.02

P.03

P.04 FRENTE

P.04 VERSO

P.05

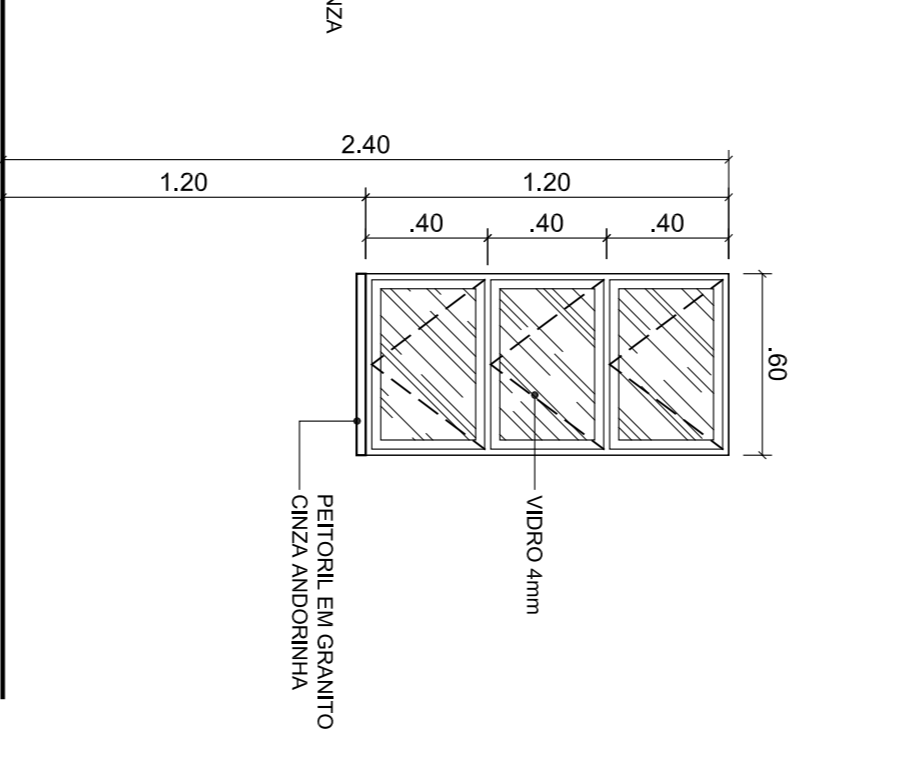
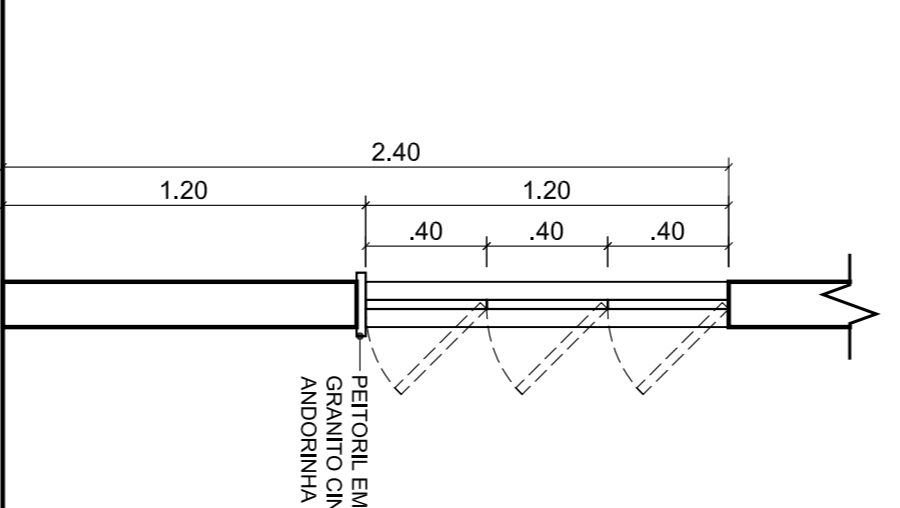
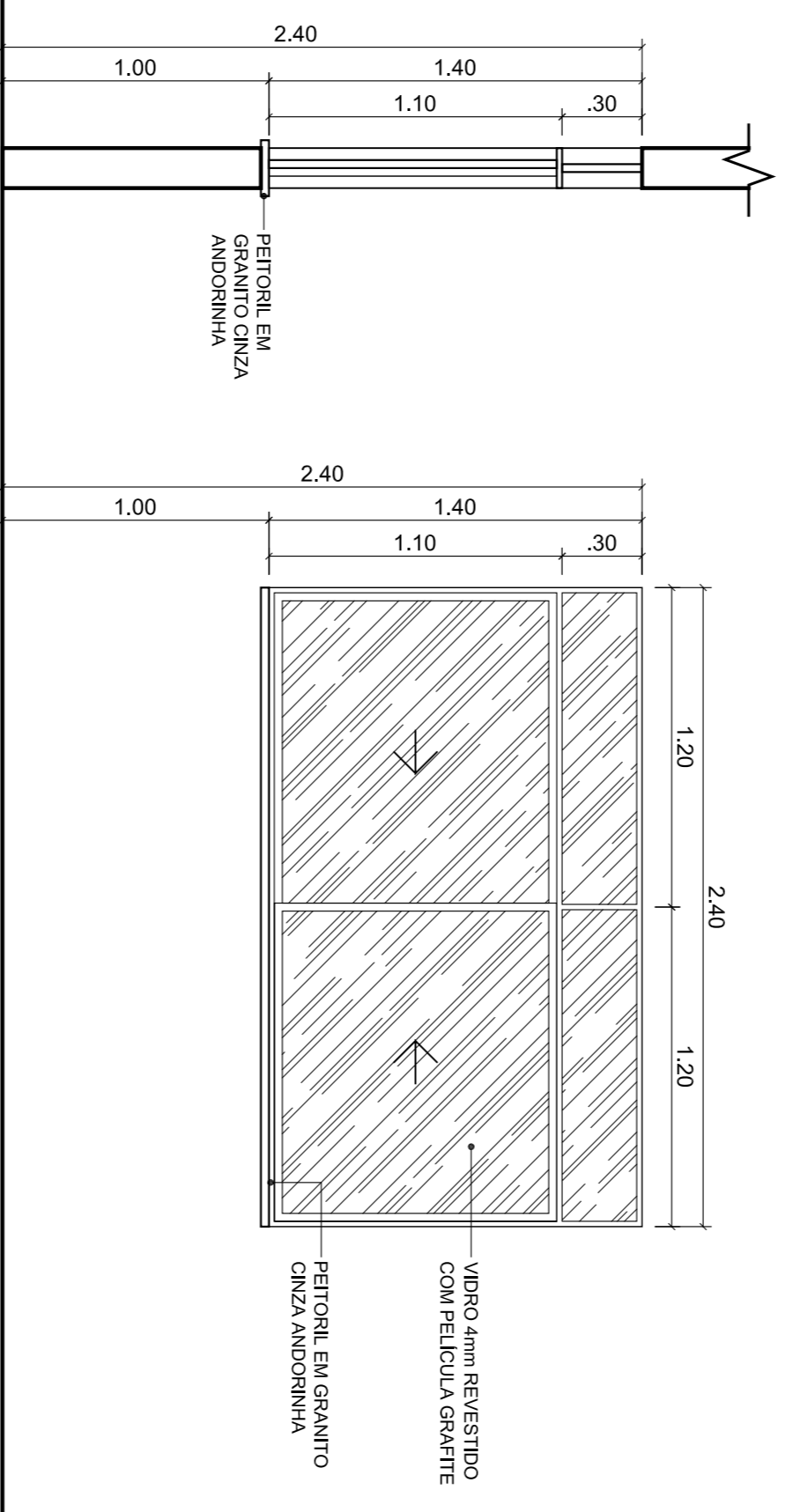

J.01

J.02

J.03

J.04

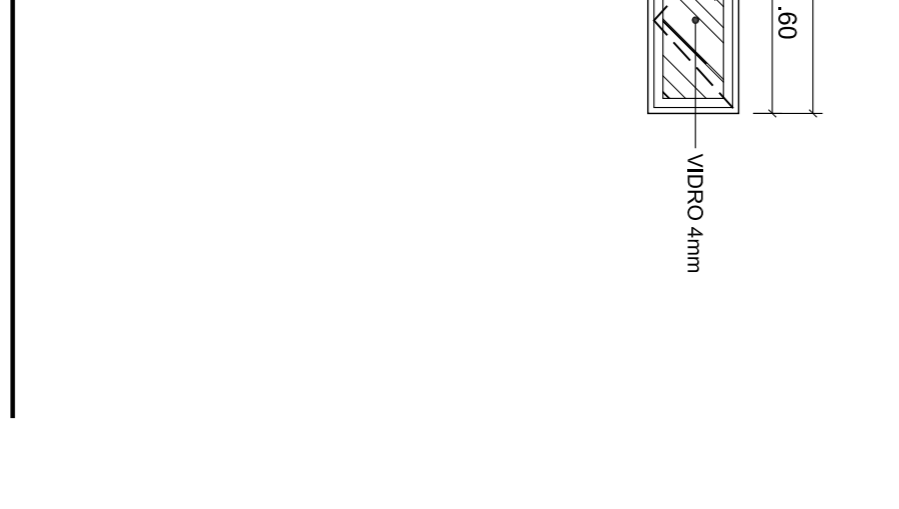
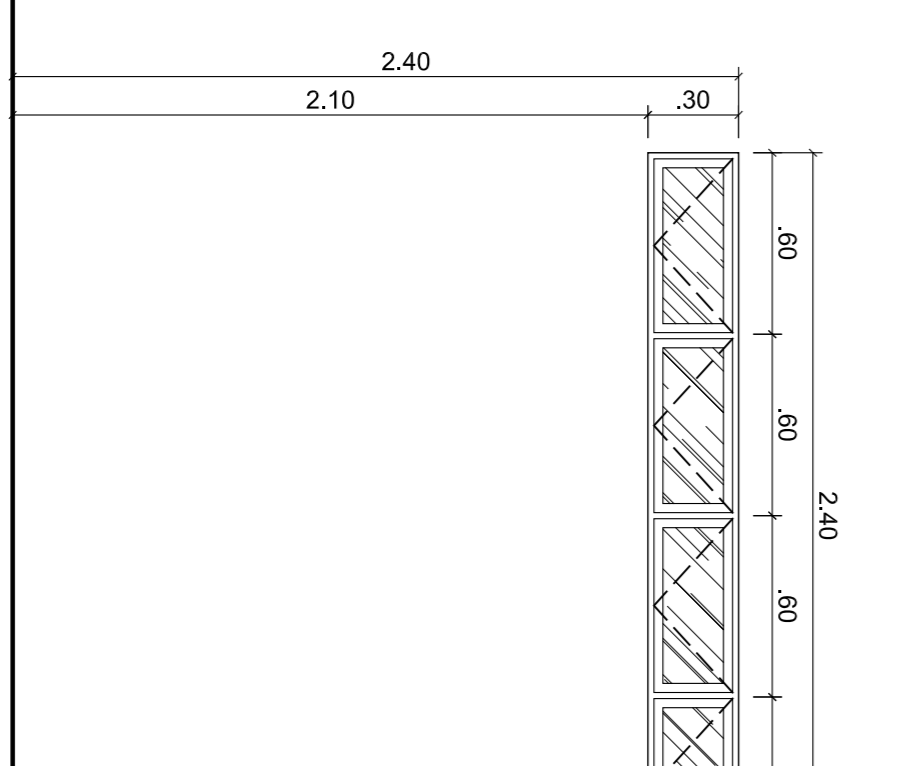
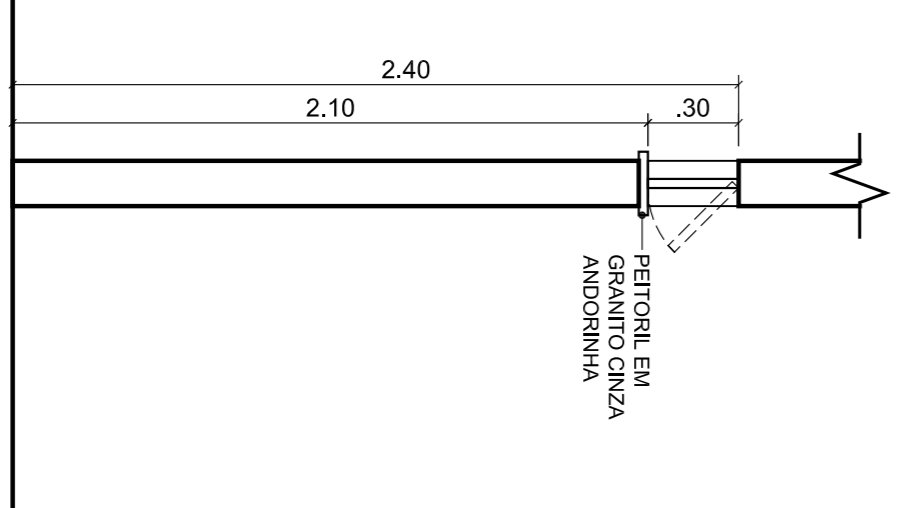
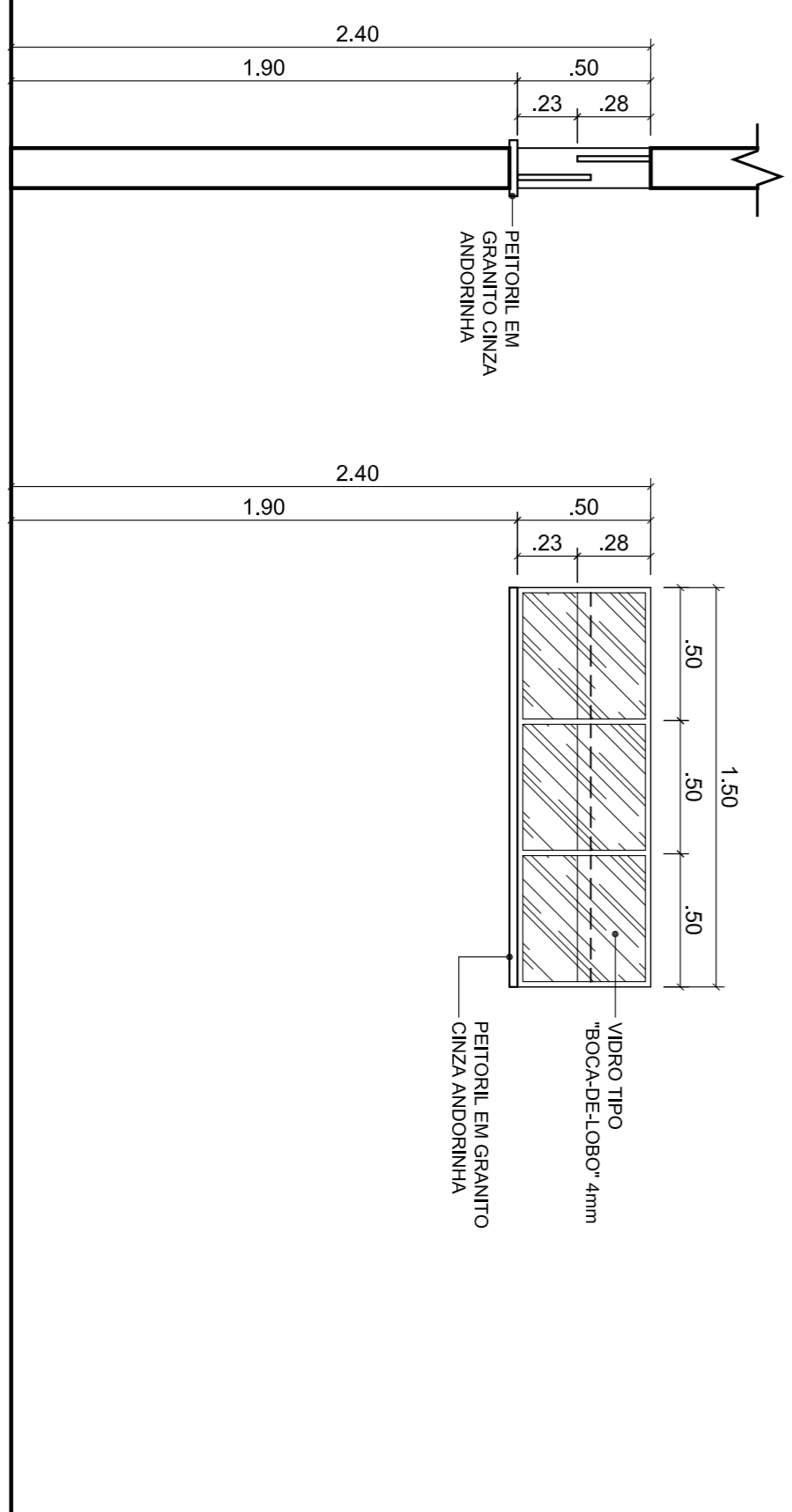

J.03

J.04

QUADRO DE ESQUADRIAS

ESQ	ABERTURA	DIMENSÃO VAO	BANDEIRA	MATERIAL	QUANT
P.01	GIRO/FIXA	5,44' x 2,10'	55'	VIDRO 10mm TEMPERADO REVESTIDO COM PELICULA GRANTE DIVULX 35 COR BRANCA COM CAXILHO DE ALUMINIO COR NATURAL E VISOR EM VIDRO TRANSPARENTE 4mm	01
P.02	GIRO	0,90 x 2,10	-	CHAPA DIVULX 35 COR BRANCA COM CAXILHO DE ALUMINIO COR NATURAL	22
P.03	GIRO	0,90 x 2,10	-	CHAPA DIVULX 35 COR BRANCA COM CAXILHO DE ALUMINIO COR NATURAL	45
P.04	GIRO	0,90 x 2,10	-	CHAPA DIVULX 35 COR BRANCA COM CAXILHO DE ALUMINIO COR NATURAL	08
P.05	GIRO	0,60 x 1,65	-	MOF REVESTIDO COM LAMINADO MELAMINICO BRANCO E CAXILHO EM ALUMINIO COR NATURAL	08
JANELAS					
ESQ	ABERTURA	DIMENSÃO VAO	PETITRIL	MATERIAL	QUANT
J.01	CORRER	2,40 x 1,40	1,40	CAXILHO EM ALUMINIO COR NATURAL E VIDRO TRANSPARENTE 4mm COM PELICULA GRANTE	164
J.02	MAXIMAR	0,60 x 1,20	1,20	CAXILHO EM ALUMINIO COR NATURAL E VIDRO TRANSPARENTE 4mm	07
J.03	BROCHAS-LOBO	1,50 x 0,50	1,50	CAXILHO EM ALUMINIO COR NATURAL E VIDRO TRANSPARENTE 4mm	09
J.04	MAXIMAR	2,40 x 0,30	2,10	CAXILHO EM ALUMINIO COR NATURAL E VIDRO TRANSPARENTE 4mm	84

*CONFIRMAR MEDIDA DO VAO NO LOCAL

CARIMBOS:

UNIVERSIDADE FEDERAL DO RIO GRANDE DO NORTE
Superintendência de Infra-estrutura

RESPONSÁVEL TÉCNICO EM ARQUITETURA: DANIEL FERNANDES DE MACEDO
RESPONSÁVEL PELTA OBRA: DANIEL FERNANDES DE MACEDO

PROFESSOR RESPONSÁVEL: ENG. GUSTAVO FERNANDES ROSADO COELHO
AUTOR DO PROJETO: DANIEL FERNANDES DE MACEDO

LOCAL: IFRN - CAMPUS CENTRAL
CENÁRIO DE CIEDNOMAS HUMANAS, LETRAS E ARTES - CHILA
PROFESSOR RESPONSÁVEL: DANIEL FERNANDES DE MACEDO

PROFESSOR RESPONSÁVEL: DANIEL FERNANDES DE MACEDO
AUTOR DO PROJETO: DANIEL FERNANDES DE MACEDO

PROFESSOR RESPONSÁVEL: DANIEL FERNANDES DE MACEDO
AUTOR DO PROJETO: DANIEL FERNANDES DE MACEDO